

# Operating instructions for washing machines



To avoid the risk of accidents or damage to the machine, it is **essential** to read these instructions before it is installed and used for the first time.

# Caring for the environment

---

## Disposal of the packing material

The packaging is designed to protect the washing machine from damage during transportation. The packaging materials used are selected from materials which are environmentally friendly for disposal and should be recycled.

Recycling the packaging reduces the use of raw materials in the manufacturing process and also reduces the amount of waste in landfill sites. Ensure that any plastic wrappings, bags etc. are disposed of safely and kept out of the reach of babies and young children. Danger of suffocation.

## Disposal of your old machine

Electrical and electronic machines often contain valuable materials. They also contain materials which, if handled or disposed of incorrectly, could be potentially hazardous to human health and to the environment. They are, however, essential for the correct functioning of your machine. Please do not therefore dispose of it with your household waste.

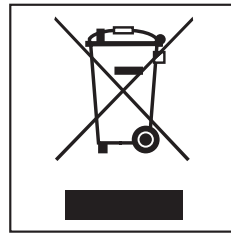

Please dispose of it at your local community waste collection / recycling centre or contact your Dealer for advice.

Ensure that it presents no danger to children while being stored for disposal.

<b>Caring for the environment</b> .....	2
<b>Warning and Safety instructions</b> .....	6
<b>Operating the washing machine</b> .....	13
Control panel.....	13
Display .....	14
Programmable functions.....	14
<b>Before using for the first time</b> .....	15
Running the first programme .....	15
<b>Washing environmentally and economically</b> .....	16
<b>1. Prepare the laundry</b> .....	17
<b>2. Select a programme</b> .....	18
<b>3. Load the washing machine</b> .....	19
Open the door.....	19
<b>4. Select programme settings</b> .....	20
Select an extra option(s) .....	20
<b>5. Add detergent</b> .....	21
<b>6. Start the programme - the end of a programme</b> .....	22
<b>Extra options</b> .....	23
Short .....	23
Pre-wash .....	23
Soak .....	23
Water plus .....	23
<b>Spinning</b> .....	24
<b>Programme chart</b> .....	25
<b>Programme sequence</b> .....	28
<b>Garment care label symbols</b> .....	30

# Contents

---

<b>Changing the programme sequence</b> .....	31
Cancelling a programme .....	31
Removing laundry after cancelling the programme .....	31
Interrupting a programme .....	31
Changing a programme .....	31
Temperature .....	31
Spin speed .....	31
Extra options .....	31
Adding or removing laundry after the programme has started .....	32
<b>Detergent</b> .....	33
The correct detergent .....	33
Definition of the soiling level .....	33
Dispensing aids .....	33
Water softeners .....	33
Fabric conditioner and liquid starch .....	33
Miele recommended detergents .....	34
Recommended detergents in accordance with Directive (EU) Nr. 1015/2010 .....	35
Adding fabric conditioner or liquid starch separately .....	36
<b>Cleaning and care</b> .....	37
Cleaning the drum .....	37
External casing and fascia panel .....	37
Cleaning the detergent dispenser drawer .....	37
Cleaning the water inlet filters .....	39
<b>Problem solving guide</b> .....	40
The programme does not start .....	40
The wash programme stops and a fault indicator light comes on .....	41
A check or fault indicator light comes on but the wash programme continues as normal .....	42
General problems with the washing machine .....	43
An unsatisfactory wash result .....	44
The door will not open .....	45
Opening the door in the event of a blocked drain outlet and/or power failure .....	46
Procedure for draining the washing machine .....	46
Opening the door .....	47
<b>After sales service</b> .....	48
Repairs .....	48
Guarantee: U.K. ....	48
Guarantee: Other countries .....	48
Optional accessories .....	48

---

<b>Installation and connection</b> .....	49
Front view.....	49
Rear view .....	50
Installation surface.....	51
Removing the transit bars.....	51
Re-fitting the transit bars .....	53
Levelling the machine .....	54
Screwing out and adjusting the feet .....	54
Washer-dryer stack.....	55
Building under a continuous worktop/ in a kitchen run .....	55
Please note: .....	55
The water protection system .....	56
Connection to the water supply.....	57
Connection to the drainage system .....	58
Electrical connection U.K.....	59
<b>Technical data</b> .....	60
<b>Consumption data</b> .....	61
Note for test institutes.....	61
<b>Programmable functions</b> .....	62
Water plus system .....	62
Gentle action.....	63
Suds cooling .....	64
Memory.....	65
Soak duration.....	66
<b>Optional accessories</b> .....	67
Detergent .....	67
Specialist detergents .....	67
Fabric care .....	68

## Warning and Safety instructions

---

This washing machine complies with current safety requirements. Inappropriate use can, however, lead to personal injury and damage to property.

To avoid the risk of accidents and damage to the machine, please read these instructions carefully before using it for the first time. They contain important information on its safety, use and maintenance.

Keep these instructions in a safe place and ensure that new users are familiar with the content. Pass them on to any future user.

### Correct application

- ▶ This washing machine is intended for use in domestic households and similar working and residential environments.
- ▶ The washing machine is not intended for outdoor use.
- ▶ It must be used only as a domestic appliance to wash items which are specified by the manufacturer as being washable on the wash care label. Miele cannot be held liable for damage resulting from incorrect or improper use or operation.
- ▶ The washing machine can only be used by people with reduced physical, sensory or mental capabilities, or lack of experience or knowledge, if they are supervised whilst using it or have been shown how to use it safely and recognise and understand the consequences of incorrect operation.

### Safety with children

- ▶ Children under 8 years of age must be kept away from the washing machine unless they are constantly supervised.
- ▶ Children 8 years and older may only use the washing machine unsupervised if they have been shown how to use it safely and recognise and understand the consequences of incorrect operation.
- ▶ Children must not be allowed to clean or maintain the washing machine unsupervised.
- ▶ Please supervise children in the vicinity of the washing machine and do not let them play with it.
- ▶ For machines with a 'porthole' door, remember that the porthole glass will be hot when washing at very high temperatures. Do not let children touch it.

### Technical safety

- ▶ Please observe the instructions in "Installation and connection" and "Technical data".
- ▶ Before setting up the washing machine, check it for any externally visible damage. Do not install or use a damaged machine.
- ▶ Before connecting the washing machine, ensure that the connection data on the data plate (fuse rating, voltage and frequency) match the mains electricity supply. If in any doubt, consult a qualified electrician.

## Warning and Safety instructions

---

► Reliable and safe operation of this washing machine can only be assured if it has been connected to the mains electricity supply.

► The electrical safety of this washing machine can only be guaranteed when correctly earthed.

It is essential that this standard safety requirement is met. If in any doubt, please have the wiring system of the building tested by a qualified electrician.

Miele cannot be held liable for the consequences of an inadequate earthing system (e.g. electric shock).

► Do not connect the washing machine to the mains electricity supply by a multi-socket adapter, extension lead or similar. These do not guarantee the required safety of the machine (fire hazard due to the risk of overheating).

► Faulty components must only be replaced by genuine Miele original spare parts. Only when these parts are fitted can Miele guarantee the safety standards of the machine.

► The electrical socket must be easily accessible after installation so that the machine can be disconnected from the electricity supply if necessary.

► Unauthorised repairs could result in unforeseen dangers for the user, for which the manufacturer cannot accept liability. Repairs should only be undertaken by a Miele authorised service technician, otherwise any subsequent damage will not be covered by the guarantee.

► If the electrical connection cable is faulty it must only be replaced by a Miele authorised service technician to protect the user from danger.



## Warning and Safety instructions

---

- ▶ The machine must be isolated from the electricity supply when cleaning and maintaining the machine and in the event of a fault.
- ▶ The machine must only be connected to the on-site water supply using a new hose kit. Old hose kits must not be re-used. Check the condition of the hoses regularly so that you can replace them in good time and avoid the risk of any water damage.
- ▶ The water flow pressure must be at least 100 kPa and should not exceed 1000 kPa.
- ▶ In areas which may be subject to infestation by cockroaches or other vermin, pay particular attention to keeping the machine and its surroundings in a clean condition at all times. Any damage which may be caused by cockroaches or other vermin will not be covered by the guarantee.
- ▶ The machine must not be used in a non-stationary location (e.g. on a ship).
- ▶ Do not make any alterations to the machine, unless authorised to do so by Miele.

# Warning and Safety instructions

---

## Correct use

- ▶ Do not install the washing machine in a room where there is a risk of frost. Frozen hoses may burst or split. The reliability of the electronic control unit may be impaired at temperatures below freezing point.
- ▶ Before using the machine for the first time, check that the transit bars at the rear of the machine have been removed (see "Installation and connection - Removing the transit bars"). During spinning, a transit bar which is still in place may result in damage to both the machine and adjacent furniture or appliances.
- ▶ Turn off the stopcock if the machine is to be left for any length of time (e.g. holiday), especially if there is no floor drain (gully) in the immediate vicinity.
- ▶ Flooding danger.  
If hooking the drain hose into a wash basin, check that the water can drain off quickly enough to prevent the sink from overflowing. Make sure the drain hose is secure, so that the force of the water flowing out of the hose does not dislodge it.
- ▶ Take care to ensure that foreign objects (e.g. nails, pins, coins, paper clips) do not find their way into the machine with the laundry. These may damage components of the machine (e.g. suds container, drum), which in turn can result in damage to the laundry.

## Warning and Safety instructions

---

- ▶ The maximum load for this washing machine is 7 kg (dry weight). See the "Programme chart" for the maximum recommended loads for individual programmes.
- ▶ If the correct amount of detergent is dispensed, the machine should not need to be descaled. If, however, you do wish to descale it, only use a proprietary natural citric acid based descaling agent. Miele recommends using Miele descaling agent which is available to order online at [www.miele-shop.com](http://www.miele-shop.com) or from Miele. Strictly observe the instructions on the packaging.
- ▶ Textiles which have been pre-treated in solvent based cleaning agents must be thoroughly rinsed in clean water before being washed in the machine.
- ▶ Do not use solvent based cleaning agents, e.g. those containing benzene, in this machine, as this may result in damage to component parts and create toxic fumes. Such agents also pose a fire and explosion hazard.
- ▶ Do not use solvent based cleaning agents, e.g. those containing benzene, to clean the surfaces of the machine. They can cause damage to plastic surfaces.
- ▶ Only use dyes specified by the manufacturer as being suitable for use in a domestic washing machine. Always observe the manufacturer's instructions carefully.

## Warning and Safety instructions

---

- ▶ Colour run and dye removers contain sulphur compounds which can cause damage such as corrosion. Do not use these products in this machine.
- ▶ If detergent comes into contact with the eyes, rinse them thoroughly with lukewarm water immediately. If swallowed, seek medical assistance immediately and retain the packaging or label for reference. Those with skin problems or sensitive skin should avoid their skin coming into contact with detergent.

### Accessories

- ▶ Accessory parts may only be fitted when expressly approved by Miele. If other parts are used, guarantee, performance and product liability claims will be invalidated.
- ▶ A Miele tumble dryer can be stacked on top of a Miele washing machine using the appropriate stacking kit (available as an optional accessory). Please make sure you order the correct one for the Miele washing machine and Miele tumble dryer.
- ▶ If installing the machine on a Miele plinth, (available as an optional accessory, depending on country), please make sure you order the correct one for this washing machine.

Miele cannot be held liable for damage caused by non-compliance with these Warning and Safety instructions.

# Operating the washing machine

## Control panel

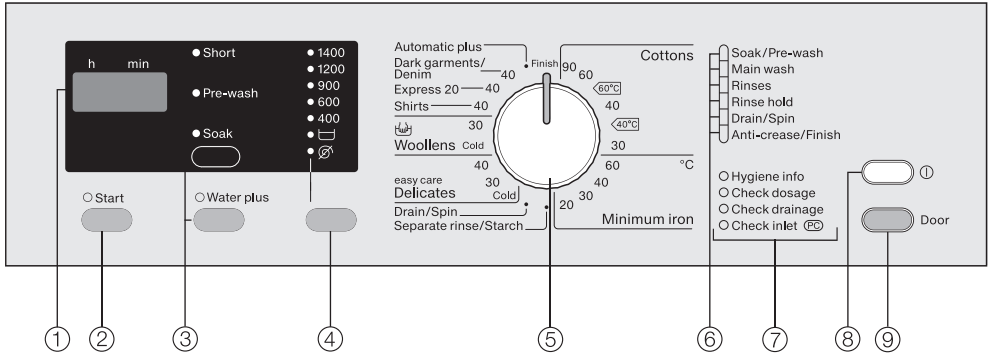

- 1 Display**  
See the next page for more information.
- 2 Start button**  
For starting the wash programme.
- 3 Extra option buttons**  
For selecting extra options. Use the upper button to select either *Short*, *Pre-wash* or *Soak*. Use the lower button to select *Water plus*.  
Indicator light on = option selected  
Indicator light off = option not selected
- 4 Spin button with spin speed indicator lights**  
For selecting the spin speed.
- 5 Programme selector**  
For selecting the wash programme and temperature for that programme. The programme selector can be turned clockwise or anti-clockwise.
- 6 Programme sequence indicator lights**  
Show which stage of the programme has been reached.
- 7 Check / Fault indicator lights**
  - see "Problem solving guide".
  - The PC check light is also used by service technicians to run diagnostic checks and may be used to update programming data in the future.
- 8 On/Off button**  
For switching the washing machine on and off.  
To save energy the washing machine will switch off automatically 15 minutes after the end of the programme/anti-crease phase or after being switched on if no other selection is made.
- 9 Door button**  
For opening the door.

# Operating the washing machine

---

## **Display**

The display shows:

- the programme duration (time left display)
- the programmable functions

## **Programmable functions**

The programmable functions can be used to tailor washing programmes to suit your personal requirements. In programming mode, the display will show the function selected.

## Before using for the first time

 Before using the machine for the first time ensure that it is correctly installed and connected. See "Installation and connection". Also check that the drain filters are securely tightened to prevent the risk of water leaks during use.

This washing machine has undergone a complete functional test at the factory and there will be some residual water in the drum from this process.

For safety reasons, spinning is not possible until the machine has been prepared for using for the first time. To activate the spinning function you must run a wash programme without laundry and without detergent.

Using detergent could result in an excessive build-up of foam.

This also activates the ball valve. The ball valve prevents detergent escaping from the suds container into the sump during a wash programme, thus making maximum use of the detergent.

### Running the first programme

- Open the stopcock.
- Press the  button in.
- Turn the programme selector to *Cot-tons 60°C*.
- Press the *Start* button.

When the programme has finished, your machine is ready to use for the first time.

- Switch the washing machine off with the  button at the end of the programme.

# Washing environmentally and economically

---

## Energy and water consumption

- Water consumption and energy usage are determined by the size of the load.  
To make the most of your machine, load the maximum dry load for the programme you are using.
- When smaller amounts of laundry are washed, the automatic load recognition system will reduce the amount of water and energy used.
- Use the *Express 20* programme for small, lightly soiled loads.
- Modern detergents make it possible to wash at lower temperatures (e.g. 20°C). Washing using lower temperature settings will save energy.
- Use the *Soak* extra option instead of *Pre-wash*. If Soak is followed immediately by a main wash, the same suds are used.
- To maintain the hygiene of the machine, carry out a hot wash (60°C or above) using powder detergent at regular intervals. The *Hygiene info* check light will appear to remind you to carry out a hot wash.

## Detergent

- Do not exceed the amounts of detergent recommended by the manufacturer on the packaging.
- Adjust the dosage to the degree of soiling of the laundry.
- Reduce the amount of detergent with smaller loads (approx.  $\frac{1}{3}$  less than the amount recommended can be used when washing a half load).

## Choosing the correct extra option (Short, Soak, Pre-wash)

Select:

- A wash programme together with the Short extra option *for light to normal soiling* where there are no obvious marks.
- A wash programme without any extra options for normal to heavy soiling with visible staining.
- A wash programme together with the *Soak* extra option for heavily soiled laundry.
- The *Pre-wash* extra option for laundry with large amounts of dirt (e.g. dust, sand).

## When drying with a tumble dryer

Selecting the highest possible spin speed for the wash programme will save energy when drying in a tumble dryer afterwards.



# 1. Prepare the laundry

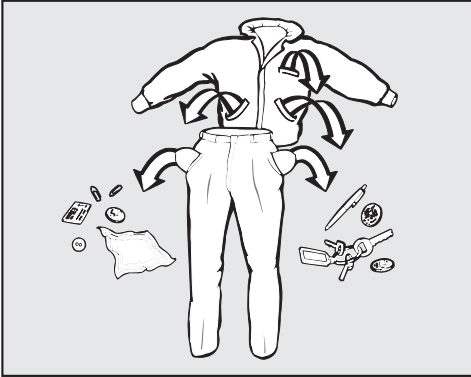

- Empty all pockets.

⚠ Foreign objects (e.g. nails, coins, paper clips, etc.) can cause damage to garments and to components in the machine.

## Sort the laundry

- Sort the laundry by colour and by care label. Most garments have a textile care label in the collar or side seam.

**Tip:** Dark textiles often contain excess dye and should be washed separately several times before being included in a mixed load. Always wash whites and coloureds separately.

## Pre-treat stains

- Badly soiled areas, stains etc. should be cleaned as soon as possible, preferably whilst still fresh. Spillages should be carefully dabbed off using a soft, colourfast cloth. Do not rub.

**Tip:** Badly soiled areas can be pre-treated with liquid detergent, stain removers etc. first, following the manufacturer's instructions. With particularly stubborn stains ask your dry cleaner for advice.

⚠ If you use a solvent-based cleaning agent (e.g. one containing benzene) to pre-treat a stain, make sure that any plastic parts (e.g. buttons) are protected, and that the cleaning agent is rinsed off before washing the garment in the machine.

⚠ Do not use solvent-based cleaning agents in or on this machine.

## General tips

- Curtains: Remove lead weights first or place in a laundry bag.
- Underwiring and collar stiffeners: Any loose wiring in bras, shirt collar stiffeners, etc. should be removed or sewn in.
- Close any zips, attach velcro fasteners, fasten hooks and eyes etc. before washing.
- Fasten duvet covers, pillow cases etc. to prevent small items from being rolled up inside them.

Do not wash any items in this washing machine which are specified by the manufacturer as **not washable** on the care label (🚫 symbol).

## 2. Select a programme

---

### Switch on the washing machine

- Press the ① button.

### Programme selection

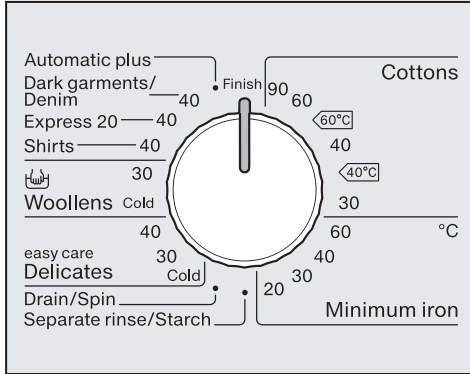

- Turn the programme selector to the required programme.

The display shows the estimated programme duration.

During the first 10 minutes, the machine measures how much water is being absorbed by the laundry. The programme duration may be longer or shorter depending on the is absorbency rate.

### 3. Load the washing machine

#### Open the door

- Press the *Door* button to open the door.
- Unfold the laundry and load loosely into the drum.

Mixing both large and small items gives better wash results and also helps distribute the load evenly during spinning.

Please note the maximum load for the different wash programmes. The relevant programme load is always shown in the display when you select a programme.

The most efficient use of energy and water is achieved when a full load is washed. However, do not overload as this reduces cleaning efficiency and causes creases.

#### Close the door

Make sure that no items are caught between the door and the seal.

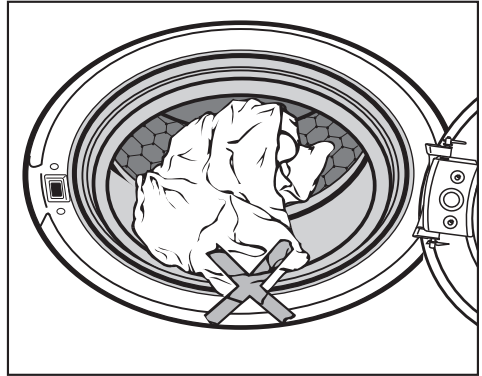

- Shut the door with a gentle swing.

## 4. Select programme settings

### Select an extra option(s)

Each press of the upper button selects the extra options: *Soak* or *Pre-wash* or *Short* or no extra option.

Use the lower button to select the *Water plus* extra option.

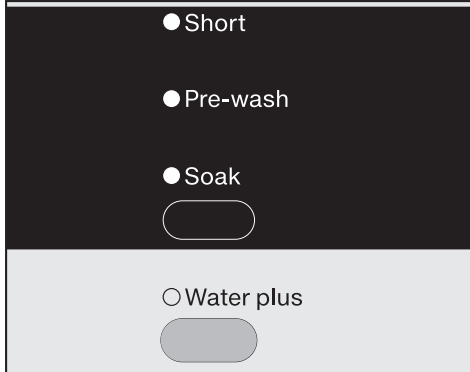

- Select the extra option(s) you want.

**Tip:** Not all the extra options are suitable for use with every programme.

You can only select extra options which are compatible with the programme being used.

### Select a spin speed

You can alter the pre-set spin speed of a wash programme.

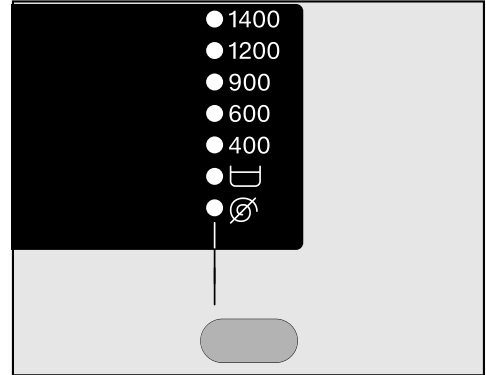

- Press the Spin button repeatedly until the indicator light of the spin speed you want comes on.

## 5. Add detergent

It is important to dispense the correct amount, because . . .

. . . too little detergent results in:

- Laundry not getting properly clean and with time it may become grey and hard to the touch.
- Greasy particles clinging to laundry.
- Limescale deposits on the heater elements.

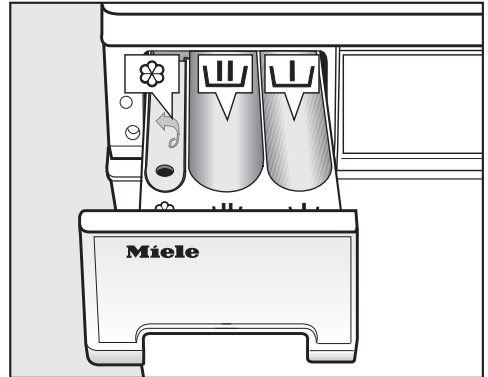

. . . too much detergent results in:

- Excessive foam which causes a low level of agitation and poor wash, rinse and spin results.
- High water consumption (an additional rinse cycle will automatically switch in).
- A burden to the environment.



- Pull out the detergent dispenser drawer and add detergent to the compartments as follows:



Detergent for the pre-wash (divide the total recommended amount as follows: add  $\frac{1}{3}$  to compartment  and  $\frac{2}{3}$  to compartment )



Detergent for the main wash, including Soak, if selected



Fabric conditioner or liquid starch

- Close the detergent dispenser drawer.

**Tip:** See "Detergent" for further information.

## 6. Start the programme - the end of a programme

### Start the programme.

- Press the flashing *Start* button.

### At the end of a programme

When the programme has finished the *Anti-crease/Finish* indicator light will light up in the programme sequence display and an *U* will appear in the display.

The washing machine will switch off automatically 15 minutes after the end of the anti-crease phase. Press the ① button to switch it back on again.

- Press the *Door* button to open the door.
- Remove the laundry.

Check that all items have been removed from the drum. Items left in the drum could discolour other items in the next wash or become discoloured themselves.

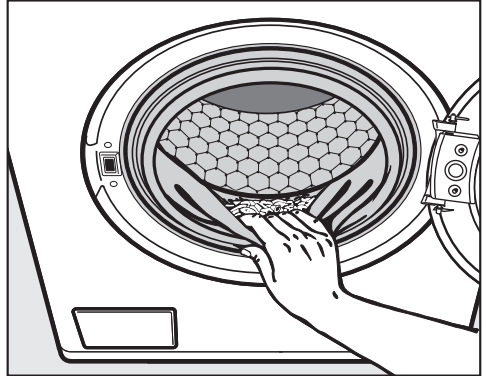

- Check the folds in the door seal for any small articles, e.g. buttons, which might be lodged there.
- Switch the washing machine off with the ① button and turn the programme selector to *Finish*.
- Close the door. Otherwise there is a danger of objects being placed inadvertently in the drum. If these remained unnoticed and were washed in the next load, they could damage the laundry.

You can use the extra options buttons to augment the wash programmes.

### Short

Use this option for light soiling with no visible staining.

The wash duration is reduced.

### Pre-wash

For laundry with large amounts of dirt, e.g. dust and sand.

### Soak

For heavily soiled and stained items with protein stains.

- A duration of between 30 minutes and 2 hours can be programmed in 30 minute increments for the soak process.
- The factory default setting is 2 hours.

See "Programmable functions - Soak" for instructions on how to programme a different soak period.

### Water plus

The water level in the wash and rinse stages is increased.

However, you can select other settings for *Water plus*. These are described in "Programmable functions".

### The following extra options can be selected in addition to the programme:

Only one of the following extra options can be selected at a time: *Short*, *Pre-wash* and *Soak*.

	Short	Pre-wash	Soak	Water plus
Cottons	X	X	X	X
Minimum iron	X	X	X	X
Automatic plus	-	-	-	-
Dark garments / Denim	X	X	X	-
Express 20	X <sup>1)</sup>	-	-	X
Shirts	X	X	X	X
Woolens (تلف)	-	-	-	-
Delicates	X	X	X	-
Drain / Spin	-	-	-	-
Separate rinse / Starch	-	-	-	X

X = Can be selected

- = Cannot be selected

1) = Can be deselected

# Spinning

## Final spin speed

Programme	rpm
Cottons	1400
Minimum iron	1200
Automatic plus	1200
Dark garments / Denim	1200
Express 20	1400
Shirts	600
Woolens 	1200
Delicates	600
Drain / Spin	1400
Separate rinse / Starch	1400

You can reduce the final spin speed. However, you cannot select a final spin speed higher than that shown in the chart above.

**Tip:** For programmes with a maximum spin speed not shown on the control panel, the nearest spin speed above it will light up. However, to protect the laundry the machine will only spin at the spin speed quoted in the chart.

## Rinse and interim spin

There is a spin after the main wash and between the rinses. A reduction in the final spin speed will also reduce the interim spin speed. If a spin speed of less than 700 rpm is selected for the *Cottons* programme, an additional rinse is introduced.

### To omit the final spin (Rinse hold)

- Press the Spin button until the  (Rinse hold) indicator light comes on. The laundry will not be spun and will remain suspended in the final rinse water. This reduces creasing if the laundry is not going to be removed immediately after the end of the programme.
- To start the final spin:  
Use the Spin button to select the spin speed you want. The machine will begin the final spin.
- Press the *Door* button. the water will drain away. Press the *Door* button again to open the door.

### To omit rinse and interim spin and the final spin

- Press the Spin button repeatedly until the  light comes on.

After the last rinse, the water will be pumped away and the anti-crease phase will switch in. In some programmes an additional rinse is introduced with this setting.



## Programme chart

<b>Cottons</b>		<b>30°C to 90°C</b>	<b>Max. load 7.0 kg</b>
Use for	Cotton, linen or cotton mix fabric, e.g. table linen, towelling, underwear, T-shirts etc.		
Note	Where particularly high levels of hygiene are required please select a temperature of 90°C or higher.		
<b>Cottons</b>		<b>⏪60°C/⏩40°C</b>	<b>Max. load 7.0 kg</b>
Use for	Normally soiled cotton garments.		
Note	<ul style="list-style-type: none"> <li>– These settings are the most efficient in terms of energy and water consumption for washing cottons.</li> <li>– With ⏪60°C the actual wash temperature reached will be lower than 60°C although the wash performance is the same as with the standard Cottons 60°C programme.</li> </ul>		
<b>Note for test institutes:</b>			
The test programme conforms to EN 60456 and the energy label to Directive 1061/2010.			
<b>Minimum iron</b>		<b>60°C to 20°C</b>	<b>Max. load 3.5 kg</b>
Use for	Synthetic, mixed fibre and easy care cotton.		
Note	Reduce the spin speed for fabric which creases easily.		
<b>Automatic plus</b>		<b>40°C</b>	<b>Max. load 5.0 kg</b>
Use for	Mixed loads of garments suitable for the <i>Cottons</i> and <i>Minimum iron</i> programmes.		
Note	The wash parameters (e.g. water level, wash rhythm and spin speed) are adjusted automatically in this programme to ensure the best possible care and wash result for each item.		



















## Programme chart

<b>Dark garments / Denim</b>		<b>40°C</b>	<b>Max. load 3.0 kg</b>
Use for	Black and dark items made of cotton, mixed fibre or denim.		
Notes	<ul style="list-style-type: none"> <li>– Wash inside out.</li> <li>– Denim often contains excess dye and may run during the first few washes. Wash light and dark coloured items separately.</li> </ul>		
<b>Express 20</b>		<b>40°C</b>	<b>Max. load 3.5 kg</b>
Use for	Cotton garments that have hardly been worn or are only very lightly soiled.		
Note	The <i>Short</i> option is activated automatically.		
<b>Shirts</b>		<b>40°C</b>	<b>Max. load 2.0 kg</b>
Notes	<ul style="list-style-type: none"> <li>– Pre-treat soiled cuffs and collars if necessary.</li> <li>– Wash silk shirts and blouses in the <i>Delicates</i> programme.</li> </ul>		
<b>Woollens</b> 		<b>cold and 30°C</b>	<b>Max. load 2.0 kg</b>
Use for	Machine-washable or hand-washable wool or wool blend fabric. If the care label does not specify a temperature, wash using the cold setting.		
Notes	Reduce the spin speed for items which crease easily.		
<b>Delicates</b>		<b>cold to 40°C</b>	<b>Max. load 2.0 kg</b>
Use for	Delicate garments made from synthetic fibre, mixed fibre, rayon and viscose.  Curtains, including net curtains, specified as machine-washable by the manufacturer.		
Notes	<ul style="list-style-type: none"> <li>– Dust in curtains usually makes a programme with pre-wash advisable.</li> <li>– Deselect the spin for items which crease easily.</li> </ul>		



## Programme chart

<b>Drain / Spin</b>		–
Notes	<ul style="list-style-type: none"> <li>– Drain only: Select  for the spin speed.</li> <li>– Make sure you select the appropriate spin speed.</li> </ul>	
<b>Separate rinse / Starch</b>		<b>Max. load 7.0 kg</b>
Use for	<ul style="list-style-type: none"> <li>– Rinsing handwashed items.</li> <li>– Starching table cloths, serviettes and workwear.</li> </ul>	
Notes	<ul style="list-style-type: none"> <li>– Reduce the spin speed for items which crease easily.</li> <li>– The laundry should be washed but not treated with fabric conditioner.</li> <li>– Items will be rinsed very effectively using two rinse cycles by activating the <i>Water plus</i> extra option. The <i>P2</i> or <i>P3</i> option of the Water plus system programmable function must be activated.</li> </ul>	

## Programme sequence

	Main wash		Rinses		Spinning
	Water level	Wash rhythm	Water level	Rinses	
Cottons		Ⓐ		2-4 <sup>1)2)</sup>	✓
Minimum iron		Ⓒ		2-3 <sup>3)</sup>	✓
Automatic plus		Ⓐ Ⓑ Ⓒ		2-3 <sup>3)</sup>	✓
Dark garments / Denim		Ⓑ		3	✓
Express 20		Ⓑ		1-3 <sup>3)</sup>	✓
Shirts		Ⓒ		2	✓
Woolens 		Ⓕ		2	✓
Delicates		Ⓓ		3	✓
Drain / Spin	-	-	-	-	✓
Separate rinse / Starch	-			1	✓

Please see the next page for a description of the symbols.

-  = Low water level  
 = Medium water level  
 = High water level  
Ⓐ = Intensive rhythm  
Ⓑ = Normal rhythm  
Ⓒ = Gentle rhythm  
Ⓓ = Sensitive rhythm  
Ⓔ = Ultra sensitive rhythm  
Ⓕ = Handwash rhythm  
✓ = Carried out  
– = Not carried out

The washing machine has fully electronic controls with automatic load recognition. It takes in the right amount of water required for the programme depending on the amount of laundry and its absorbency rate.

The programme sequences shown in the chart are based on the standard programme with a full load. Extra options which can be selected have not been taken into account.

### Special features in the programme sequence

#### Anti-crease:

At the end of the programme the drum continues to turn at intervals for up to 30 minutes to help prevent creasing.

Exception: There is no anti-crease phase in the *Woolens* programme.

The door can be opened at any time during the anti-crease phase.

<sup>1)</sup> A second rinse is carried out when a temperature of 60°C and above has been selected. A third rinse is carried out when a temperature below 60°C is selected.

<sup>2)</sup> A third or fourth rinse is carried out if:

- there is too much foam in the drum
- a spin speed lower than 700 rpm has been selected
-  is selected

<sup>3)</sup> A third rinse is carried out if:

-  is selected

# Garment care label symbols

Washing	
The figure quoted in the bucket is the maximum temperature the garment can be washed at. The number of bars under the symbol indicates the level of agitation permitted.	
	No bar under the symbol: = normal agitation
	One bar under the symbol: = reduced agitation
	Two bars under the symbol: = much reduced agitation
	Hand wash (if no temperature is specified, use the lowest temperature or cold)
	Do not wash

## Programme selection examples

Programme	Garment care label symbols
Cottons	
Minimum iron	
Automatic plus	
Express 20	
Woollens	
Delicates	

Drying	
The number of dots indicates the drying temperature	
	Normal temperature
	Low temperature
	Do not tumble dry

Ironing	
The number of dots indicates the ironing temperature	
	Hot iron (max. sole plate temp. approx. 200°C)
	Medium hot iron (max. sole plate temp. approx. 150°C)
	Cool iron (max. sole plate temp. approx. 110°C).  Do not steam iron garments carrying this symbol as this could cause irreversible damage.
	Do not iron

Professional cleaning	
	Dry clean only. The letters indicate the type of cleaning agent required.
	Professional Wet Clean only
	Do not dry clean

Bleaching	
	Any oxidising bleaching agent can be used
	Only use an oxygen based bleach or a non-chlorine bleach
	Do not bleach

# Changing the programme sequence

---

## Cancelling a programme

You can cancel a programme at any time after it has started:

- Turn the programme selector to *Finish*.

The water will drain away. The programme is cancelled as soon as the *Anti-crease/Finish* indicator light comes on and  appears in the display.

## Selecting a different programme after cancelling the programme

- Switch the washing machine back on with the  button.
- Check that there is still detergent in the dispenser drawer. Add more detergent if necessary.
- Turn the programme selector to the programme you want and start the programme by pressing the *Start* button.

## Removing laundry after cancelling the programme

- Turn the programme selector to *Drain/Spin*.



**Tip:** Select an appropriate spin speed.

- Press the *Start* button.

The suds will be pumped away.

- Press the *Door* button to open the door.

## Interrupting a programme

- Switch the washing machine off with the  button.
- Switch the washing machine back on with the  button to continue with the same programme.

## Changing a programme

After the start of a programme it is not possible to select a different programme.

## Temperature

It is possible to select a different temperature up to 6 minutes after the programme has started.

## Spin speed

It is possible to change the spin speed at any time.

## Extra options

It is possible to select or deselect the *Water plus* extra option up to 6 minutes after the programme has started.

# Changing the programme sequence

---

## Adding or removing laundry after the programme has started

- Press the *Door* button until the door opens.
- Add or remove items.
- Close the door.

The programme will continue automatically.

Please note:

Once a programme has started the washing machine cannot recognise any adjustment to the load.

For this reason, if laundry is added or removed after the start of a programme, the machine will always complete the programme cycle assuming a full load

This can lead to an increase in the time left displayed.

The door cannot be opened, if:

- the suds temperature is above **55°C**.
- the water is above a certain level.
- the final spin is being carried out.



## The correct detergent

All detergents produced for automatic washing machines are suitable. Follow the manufacturer's instructions and dosage recommendations on the packaging.

## The right amount to dispense will depend on the following:

- the soiling level of the load
- the quantity of the laundry
- the water hardness level.  
Check with your local water supplier if you do not know the hardness level in your area.

## Definition of the soiling level

- Lightly soiled  
No visible dirt or stains. Possibly slight body odour.
- Normally soiled  
Visibly dirty and/or just a few slight stains.
- Heavily soiled  
Soiling and/or stains clearly visible.

## Water hardness levels

Hardness scale	Hardness level in mmol/l	German scale °d
I (soft)	0 – 1.5	0 – 8.4
II (medium)	1.5 – 2.5	8.4 – 14
III (hard)	above 2.5	above 14

## Dispensing aids

Use dispensing aids, (e.g. balls) if these are supplied with the detergent, particularly when using liquid detergent.

## Refill packs of detergent

When purchasing detergent buy refill packs wherever possible. This helps reduce the amount of waste packaging.

## Water softeners

A water softener can be used to cut down on the use of detergents in areas with water hardness levels II and III. Dispense according to the amount specified on the packaging. First add detergent and then the water softener.

You can then use the recommended amount of detergent for water hardness level I.

## Fabric conditioner and liquid starch

Fabric conditioner makes garments soft to handle and helps prevent static cling when tumble drying.

Starch stiffens and gives body to items of laundry, e.g. shirts, tablecloths and bed linen.

# Detergent

---

## Miele recommended detergents

Miele detergents and care products have been specially designed for Miele washing machines. They are available to order via the internet at [www.miele-shop.com](http://www.miele-shop.com) or from Miele.

	Miele UltraWhite	Miele UltraColor	Miele Wool and delicates detergent	Miele fabric conditioner
Cottons	✓	✓	-	✓
Minimum iron	-	✓	-	✓
Automatic plus	-	✓	-	✓
Dark garments / Denim	-	✓	-	✓
Express 20	-	✓	-	✓
Shirts	✓	✓	-	✓
Wollens (wool)	-	-	✓	✓
Delicates	-	-	✓	✓
Separate rinse / Starch	-/-	-/-	-/-	✓/-

- ✓ Recommended
- Not recommended

## Recommended detergents in accordance with Directive (EU) Nr. 1015/2010

The recommendations apply to the temperature ranges given in the Programme chart.

	Universal	Coloureds	Delicates and woollens	Specialist
	detergent			
Cottons	✓	✓	-	-
Minimum iron	-	✓	-	-
Dark garments / Denim	-	✓ <sup>1)</sup>	-	✓
Express 20	-	✓ <sup>1)</sup>	-	-
Shirts	✓	✓	-	-
Woollens (👉)	-	-	✓	✓
Delicates	-	-	✓	-

✓ Recommended

- Not recommended

1) Liquid detergent

2) Powder detergent

# Detergent

## Dispensing fabric conditioner and liquid starch at the end of the programme

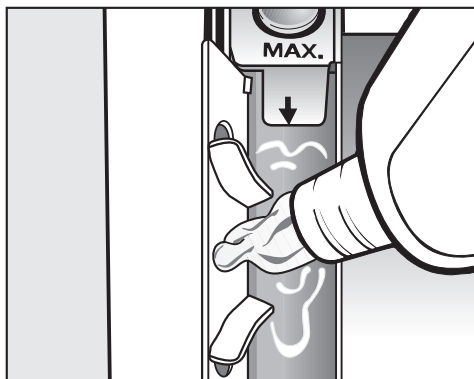

- Add the fabric conditioner or liquid starch to the ☼ compartment. **Do not exceed the maximum level mark.**

The agent will be automatically dispensed in the last rinse. At the end of the programme a small amount of water will remain in the ☼ compartment.

If starching frequently, thoroughly clean the dispenser compartment, especially the siphon tube regularly.

## Adding fabric conditioner or liquid starch separately

Prepare the starch in accordance with the manufacturer's instructions on the packaging.

- Add fabric conditioner to the ☼ compartment.
- Add liquid starch to the ☼ compartment and powder or viscous starch to the ⊥ compartment.
- Select the *Separate rinse/Starch* programme.
- Change the spin speed if necessary.
- Press the *Start* button.

## Colour run and dye removers/dyes

⚠ **Do not use** colour run or dye removers in this washing machine. They can cause corrosion in the machine.

Dyes suitable for use in domestic washing machines can be used. However, please note that the salt used in the dyeing process can cause corrosion to stainless steel components in the machine if you dye frequently. Always observe the manufacturer's instructions carefully.

## Cleaning the drum

Washing at low temperatures and/or using liquid detergent can cause bacteria and unpleasant odours to build up in the washing machine. In order to clean the drum and also to prevent unpleasant odours building up, run a programme with a temperature of at least 60°C using powder detergent once a month or when the *Hygiene info* light comes on.

## External casing and fascia panel

⚠ Disconnect the machine from the mains electricity supply before cleaning or maintenance.

⚠ The washing machine must not be hosed down.

- Clean the casing and fascia panel with a mild non-abrasive cleaning agent or soap and water using a well wrung-out cloth. Wipe dry with a soft cloth.
- The drum can be cleaned with a proprietary stainless steel cleaning agent, following the manufacturer's instructions on the packaging.

⚠ Do not use solvents, abrasive cleaners, glass cleaners or multi-purpose cleaning agents. These could damage plastic surfaces and other parts.

## Cleaning the detergent dispenser drawer

The pre-wash and main wash compartments of the detergent dispensing drawer are self-cleaning.

For hygiene reasons, clean the entire drawer at regular intervals.

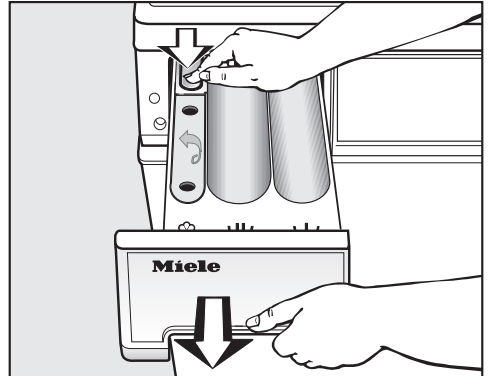

- Pull out the detergent dispenser drawer until a resistance is felt. Press down the release button and at the same time pull the drawer right out of the machine.
- Clean the drawer with hot water.

# Cleaning and care

## Cleaning the siphon

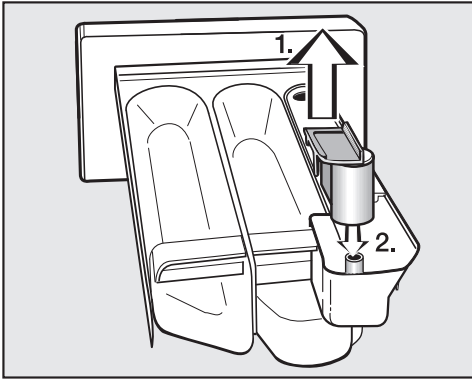

- 1. Remove the siphon from the  compartment and rinse under hot running water. Clean the siphon tube at the same time.
- 2. Replace the siphon.

Liquid starch can cause the siphon to become clogged. Make sure that you clean the siphon and siphon tube particularly thoroughly after using liquid starch a few times.

## Cleaning the detergent dispenser drawer housing

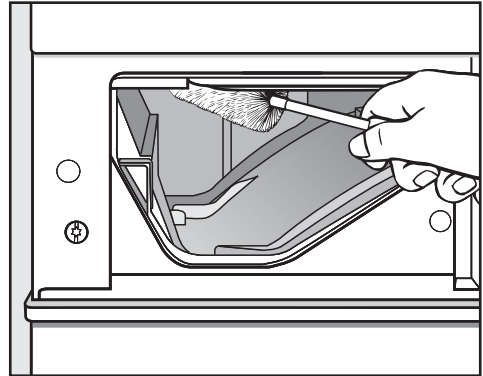

- Use a bottle brush to remove detergent residues and limescale from the jets inside the detergent dispenser drawer housing.

## Cleaning the water inlet filters

The washing machine has two filters to protect the water inlet valve. These filters should be checked every six months or so, or more often if there are frequent interruptions to the water supply.

### To clean the filter in the union in the open end of the inlet hose:

- First turn off the stopcock.
- Unscrew the inlet hose from the stopcock.

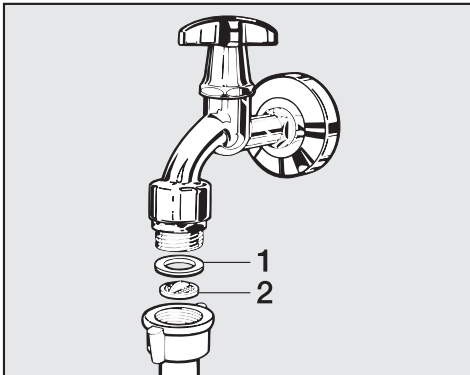

- Remove the rubber seal **1** from the recess.
- Using pointed pliers, take hold of the plastic filter bar **2** and remove it.
- Clean the filter.
- Replace the filter and seal back in the reverse order and reconnect the hose.

### To clean the filter in the water inlet valve:

- Using pliers, carefully loosen the ribbed plastic nut on the inlet valve and unscrew.

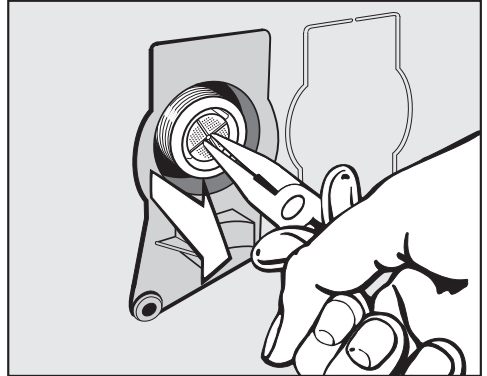

- Use pointed nose pliers to withdraw the plastic filter by the bar (see illustration).
- Clean the filter.
- Replace the filter in the reverse order.

After cleaning the filters, turn on the stopcock and check the connection is watertight. If water drips out, tighten the connection.

The two filters **must** be put back in place after cleaning.

## Problem solving guide

---

Minor faults in the performance of the washing machine, some of which may result from incorrect operation, can be put right without contacting the Service Department.

The following guide may help you to find the reason for a fault, and to correct it. You should, however, note the following:

 Repair work to electrical appliances should only be carried out by a suitably qualified person in strict accordance with current local and national safety regulations. Repairs and other work by unqualified persons could be dangerous. The manufacturer cannot be held liable for unauthorised work.

### The programme does not start

Problem	Cause and remedy
<b>The <i>Anti-crease/Finish</i> indicator light is not on or the <i>Start</i> button is not flashing.</b>	There is no power to the machine. <ul style="list-style-type: none"><li>■ Check whether the mains plug is plugged in and switched on.</li><li>■ Check whether the fuse or circuit breaker has tripped.</li><li>■ Check whether the door is closed properly.</li></ul>
	The washing machine has switched off automatically to save energy. <ul style="list-style-type: none"><li>■ Switch it back on with the  button.</li></ul>



### The wash programme stops and a fault indicator light comes on.

Problem	Cause and remedy
<b>The <i>Check drainage</i> fault indicator light flashes and a fault number appears in the display.</b>	The water outlet is blocked. <ul style="list-style-type: none"> <li>■ Clean the drain filter and the drain pump as described in "Problem solving guide – Opening the drum door in the event of a blocked water outlet and/or a power failure".</li> </ul>
	The drain hose has been fixed too high. <ul style="list-style-type: none"> <li>■ The maximum delivery head is 1 m.</li> </ul>
<b>The <i>Check inlet</i> fault indicator light flashes and a fault number appears in the display.</b>	The water inlet is blocked. <ul style="list-style-type: none"> <li>■ Open the stopcock.</li> </ul>
	The filter in the water inlet hose is dirty. <ul style="list-style-type: none"> <li>■ Clean the filter.</li> </ul>
<b>The <i>Check inlet</i> and <i>Check drainage</i> fault indicator lights flash and a fault number appears in the display.</b>	The water protection system has reacted. <ul style="list-style-type: none"> <li>■ Close the stopcock.</li> <li>■ Call the Miele Service Department.</li> </ul>
<b>The <i>Soak/Pre-wash</i> or <i>Rinses</i> flash and a fault number appears in the display.</b>	There is a fault. <ul style="list-style-type: none"> <li>■ Start the programme again. If the fault indicator comes on again, call the Miele Service Department.</li> </ul>

To switch off the fault indicator: Switch the washing machine off with the ① button and turn the programme selector to *Finish*.

## Problem solving guide

---

### A check or fault indicator light comes on but the wash programme continues as normal.

Problem	Cause and remedy
<b>The <i>Hygiene info</i> check indicator light comes on.</b>	A programme using a temperature above 60°C has not been run for a long time. <ul style="list-style-type: none"><li>■ In order to prevent bacteria and unpleasant odours building up in the machine, run the <i>Cottons 90°C</i> using powder detergent.</li></ul>
<b>The <i>Check dosage</i> check indicator light comes on.</b>	Excessive foam has built up during washing. <ul style="list-style-type: none"><li>■ Use less detergent next time, and follow the manufacturer's recommended dosage amounts on the packaging.</li></ul>
<b>The <i>Main wash or Rinses</i> indicator lights flash in the programme sequence display and a fault number appears in the display.</b>	The washing machine has detected a fault during the wash programme. <ul style="list-style-type: none"><li>■ Start the programme again. If the fault indicator comes on again, call the Miele Service Department.</li></ul>
<b>The <i>Anti-crease/Finish</i> indicator light flashes in the programme sequence display.</b>	The programme selector was moved to another position after the programme had started. <ul style="list-style-type: none"><li>■ Turn the programme selector back to the original position.</li></ul>

To switch off the fault indicator: Switch the washing machine off with the ① button and turn the programme selector to *Finish*.

The check indicator lights come on at the end of a programme and when the washing machine is switched on.

## General problems with the washing machine

Problem	Cause and remedy
<b>The machine shakes during the spin cycle.</b>	The machine feet are not level. <ul style="list-style-type: none"> <li>■ Level the machine and adjust the feet correctly.</li> </ul>
<b>The laundry has not been spun properly and is still wet.</b>	The machine detected an imbalance during the final spin cycle and reduced the spin speed automatically. <ul style="list-style-type: none"> <li>■ Include both large and small items in the load as this will give better distribution during spinning.</li> </ul>
<b>Strange pump noises can be heard.</b>	This is not a fault. These slurping noises occur at the end of the pump sequence as a normal part of operation.
<b>Large amounts of detergent residue remain in the detergent dispenser drawer.</b>	The water pressure is too low. <ul style="list-style-type: none"> <li>■ Clean the water inlet filter.</li> <li>■ It may be useful to select the <i>Water plus</i> extra option.</li> </ul>
	Powder detergent used in conjunction with water softeners tends to become sticky. <ul style="list-style-type: none"> <li>■ In future, add washing powder into the dispenser drawer first, and then add the water softener.</li> </ul>
<b>Fabric conditioner is not completely dispensed or too much water remains in the compartment.</b> ☼	The siphon tube is not correctly positioned or is clogged. <ul style="list-style-type: none"> <li>■ Clean the siphon, see "Cleaning and care - Cleaning the detergent dispenser drawer".</li> </ul>

# Problem solving guide

---

## An unsatisfactory wash result

Problem	Cause and remedy
<b>Liquid detergent does not give the required result.</b>	<p>Liquid detergents usually contain no bleaching agents. They do not remove fruit, coffee and tea stains.</p> <ul style="list-style-type: none"><li>■ Use a general purpose powder detergent containing a bleaching agent.</li><li>■ Add stain removers to compartment  of the dispenser drawer.</li><li>■ Never put stain removers and liquid detergent together in the dispenser drawer.</li></ul>
<b>Grey, greasy particles cling to washed laundry.</b>	<p>Insufficient amounts of detergent were used to break down the particles of grease in heavily soiled laundry.</p> <ul style="list-style-type: none"><li>■ Use more detergent.</li><li>■ Before washing the next load run a Cottons 60°C programme with powder detergent but without a load.</li></ul>
<b>White residues which look like powder detergent are seen on dark textiles after washing.</b>	<p>The detergent contained compounds (zeolites) to aid water softening which are not soluble in water. These have ended up on the laundry.</p> <ul style="list-style-type: none"><li>■ Try and brush off the residues with a soft brush once the laundry is dry.</li><li>■ Wash dark textiles using a detergent which contains no zeolites. Liquid detergents usually contain no zeolites.</li><li>■ Use the <i>Dark garments / Denim</i> programme for dark coloured laundry.</li></ul>

## The door will not open

Problem	Cause and remedy
<b>The drum door cannot be opened by pressing the <i>Door</i> button.</b>	The washing machine is not connected to the electrical supply and / or is not switched on. ■ Insert the plug in the socket and switch on and / or switch the machine on with the Ⓛ button.
	Power cut. ■ Open the door as described in “Opening the door in the event of blocked drain outlet and/or power failure”.
	The door was not correctly engaged. ■ Press hard against the lock side of the door and then press the <i>Door</i> button.
	There is still water in the drum and the machine is unable to drain. ■ Clean the drain filters and the drain pump.
	For safety reasons the door cannot be opened if the suds temperature is higher than 55°C. ■ Allow the programme to finish or cancel it and wait until the temperature in the drum has dropped.

## Problem solving guide

### Opening the door in the event of a blocked drain outlet and/or power failure

- Switch off the washing machine.

There is a lever behind the detergent drawer fascia panel for opening the access panel to the drain filter.

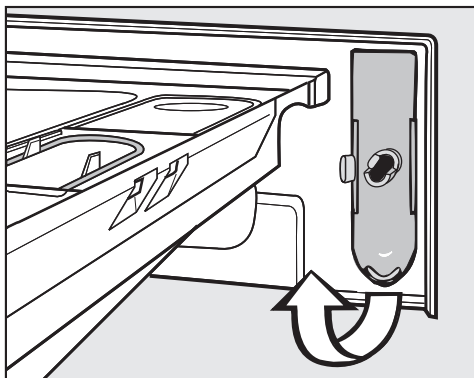

- Remove the lever.

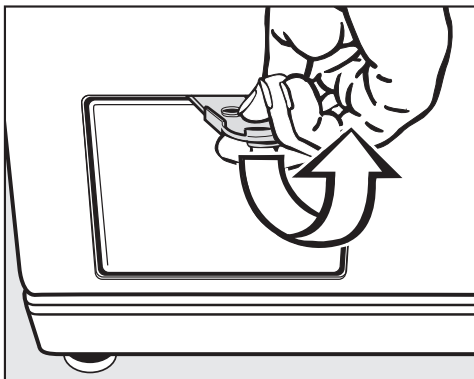

- Use it to open the access panel.

### Blocked drain outlet

If the drain outlet is blocked, a large quantity of water (**up to 25 litres**) can remain in the washing machine.

 **Caution:** If laundry has been washed at a high temperature, water draining out of the machine will still be hot. Danger of scalding!

### Procedure for draining the washing machine

- Place a suitable container under the access flap.

When draining water from the machine, do not unscrew the drain filter completely or take it right out.



- Slowly and carefully unscrew the drain filter to let the water out. Be careful not to release too much water at once. If the flow of water is too strong, some water can seep into the washing machine base and activate the water protection float switch. This will prevent the washing machine from functioning.

## Problem solving guide

- Tighten the drain filter back up again if you need to interrupt the flow of water.

Once the flow of water ceases:

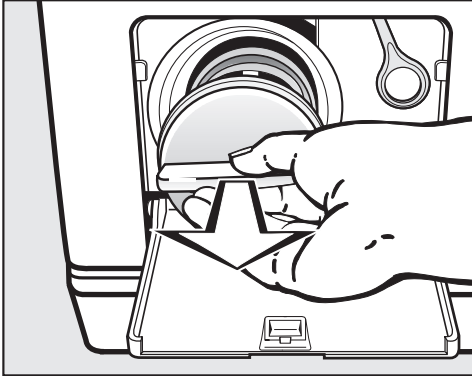

- Remove the drain filter completely.
- Clean it thoroughly.

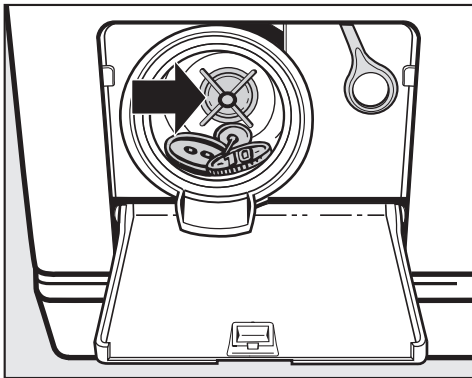

- Remove any foreign objects (e.g. buttons, coins, etc.) and fluff from the filter housing. Turn the impeller by hand to check that it rotates freely.
- Put the drain filter back in place and secure it.

⚠ Make sure the drain filter is securely tightened. Otherwise there is a risk of water leakage during use.

To avoid loss of detergent, pour approx. 2 litres of water into the detergent dispenser drawer after cleaning the drain filter. Excess water will be pumped out automatically before the next wash programme.

### Opening the door

⚠ Always make sure that the drum is stationary before reaching in to remove laundry. Reaching into a moving drum is extremely dangerous.

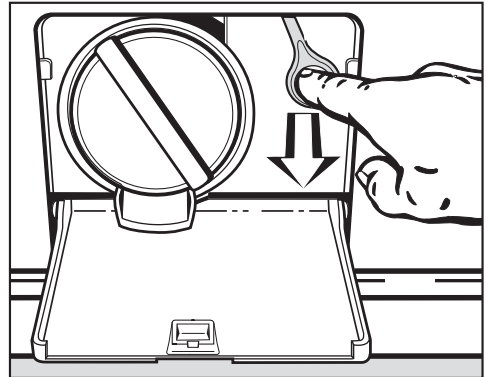

- Pull the emergency release downwards. The door will open.

# After sales service

---

## Repairs

In the event of any faults which you cannot remedy yourself, please contact:

- your Miele Dealer, or
- Miele (Contact details for Miele are given at the end of this booklet).

When contacting your Dealer or Miele, please quote the model and serial number of your machine, both of which are shown on the data plate visible above the porthole glass when the door is open.

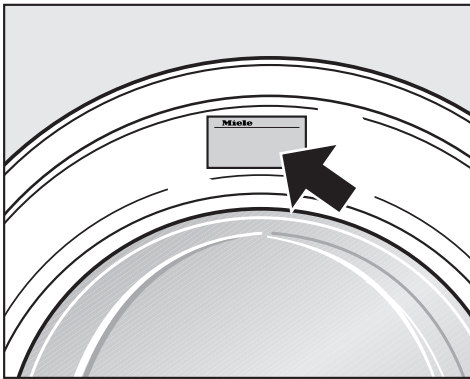

N.B. A call-out charge will be applied for service visits where the problem could have been resolved as described in these instructions.

## Guarantee: U.K.

In the U.K, the washing machine is guaranteed for 2 years from the date of purchase.

In the U.K. you must activate your cover by calling 0330 160 6640 or registering online at [www.miele.co.uk](http://www.miele.co.uk).

## Guarantee: Other countries

For information on the appliance guarantee specific to your country please contact Miele. See end of this booklet for contact details.

## Optional accessories

Optional spare parts and accessories for this washing machine are available from your Miele Dealer, the Miele Spare Parts Department or via the internet at [www.miele-shop.com](http://www.miele-shop.com).

Please note that telephone calls may be monitored and recorded for training purposes.



# Installation and connection

## Front view

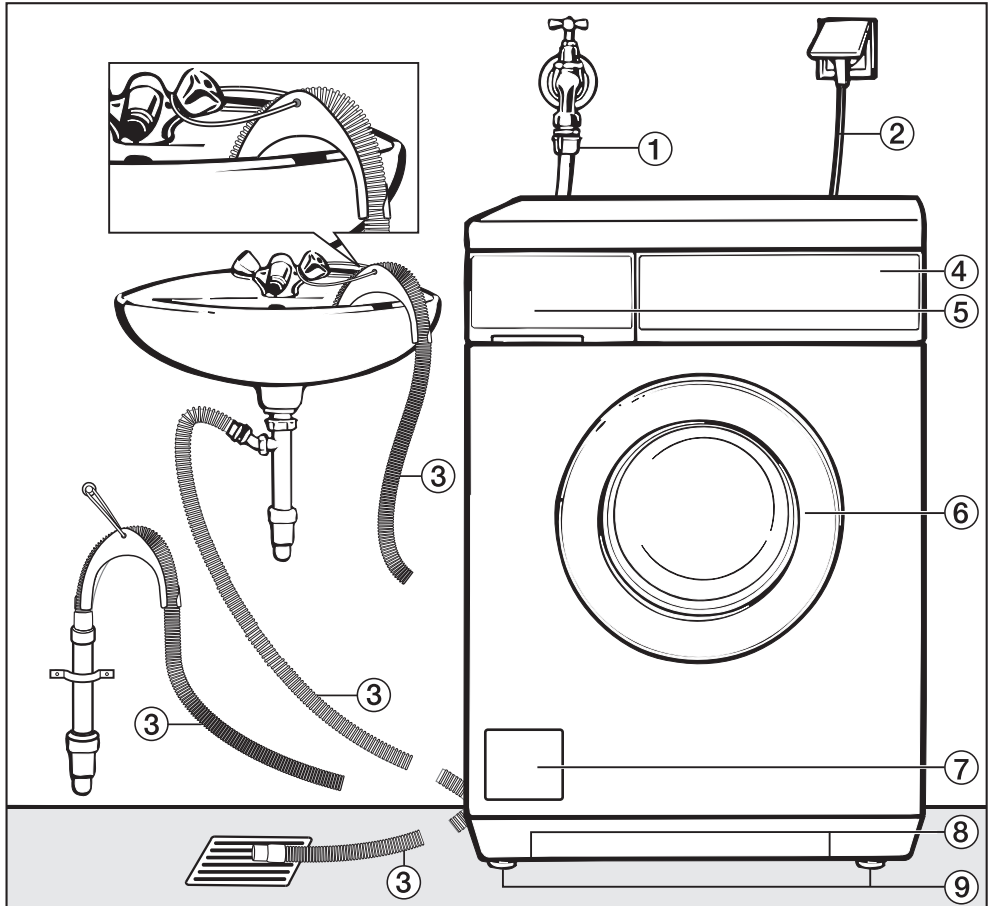

- ① Inlet hose (tested to withstand pressure of at least 7000 kPa)
- ② Electrical supply cable
- ③ Flexible drain hose (with detachable swivel elbow)
- ④ Control panel
- ⑤ Detergent dispenser drawer
- ⑥ Door
- ⑦ Access to drain filter, drain pump and emergency release
- ⑧ Handle recesses for moving the machine
- ⑨ Four height adjustable feet

# Installation and connection

## Rear view

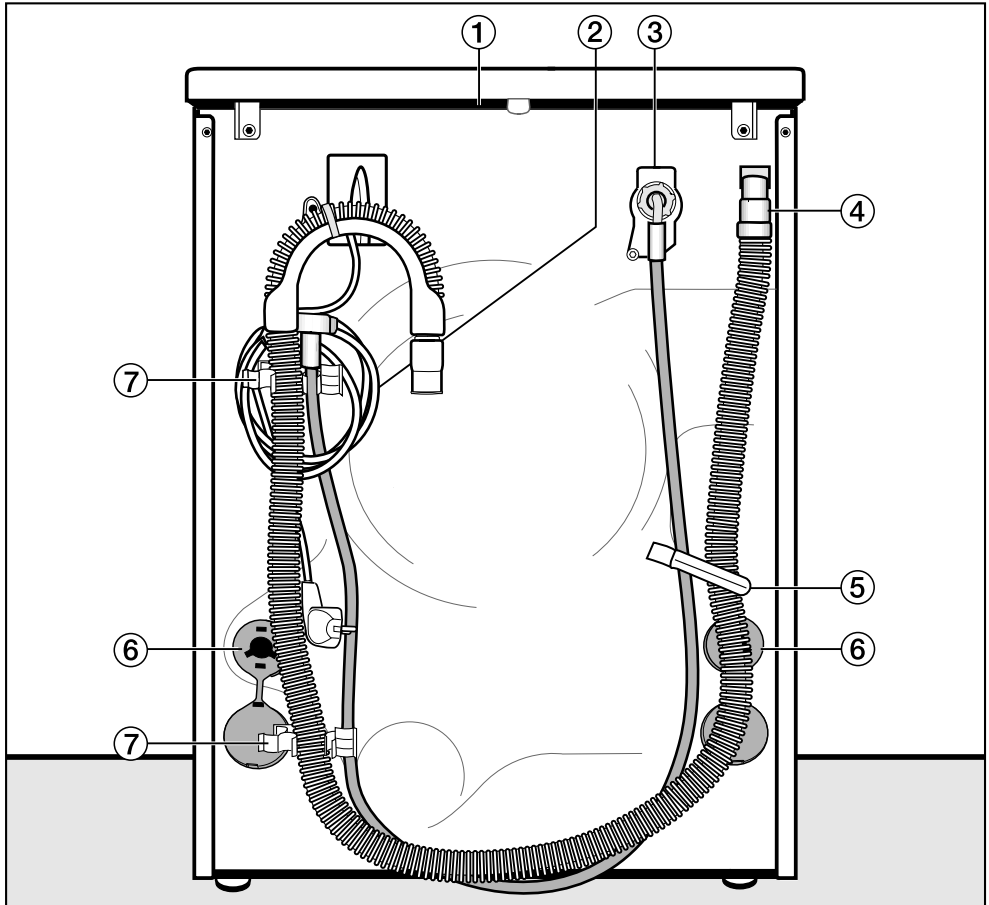

- ① Protruding lid for holding when moving the machine
- ② Electrical supply cable
- ③ Inlet hose (tested to withstand pressure of at least 7000 kPa)
- ④ Drain hose
- ⑤ Transport clip for inlet and drain hoses
- ⑥ Safety cap for transit bars
- ⑦ Transport clip for inlet and drain hoses and for storing transit bars when not in use

# Installation and connection

## Installation surface

A concrete floor is the most suitable installation surface for a washing machine, being far less prone to vibration during the spin cycle than wooden floorboards or a carpeted surface.

Please note:

- The machine must be level and securely positioned.
- To avoid vibrations during spinning, the machine should not be installed on soft floor coverings.

If installing on a wooden joist floor:

- We recommend a plywood base at least 59 x 52 x 3 cm). The base should span several joists and be bolted to the joist and not only the floorboards. Check for the presence of pipes and cables first.

**Tip:** If possible, install the machine in a corner, as this is usually the most stable part of the floor.

⚠ If the machine is installed on a raised plinth, it has to be secured against slippage during spinning using retaining clips (available from Miele). Otherwise there is the danger of the machine moving and falling off the plinth.

## Transporting the washing machine to its installation site

To manoeuvre the washing machine out of its packing case to its installation site, hold it by the edge of the lid where it protrudes to the rear of the machine as well as by the handle recesses at the front.

⚠ Ensure that the machine feet and the floor are dry to prevent the machine from slipping during the spin cycle.

## Removing the transit bars

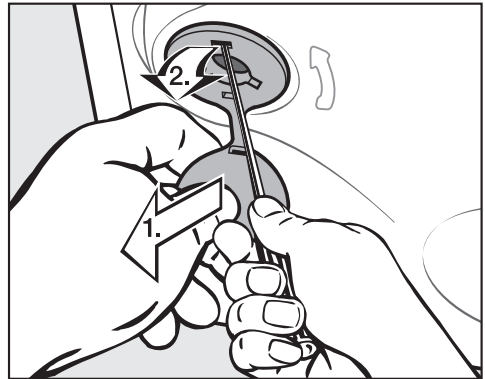

- To remove the left and right covers

1. Pull on the attached stopper,
2. then use a screwdriver to release the catches at the top and bottom.

## Installation and connection

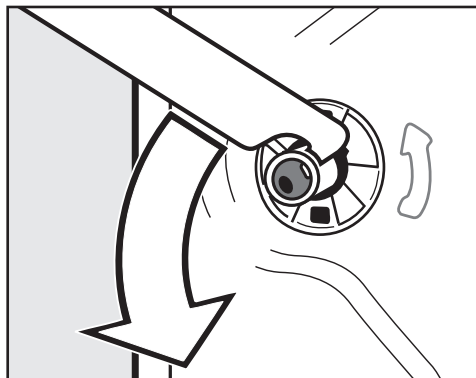

- Using the spanner supplied, turn the left-hand transit bar 90°, then

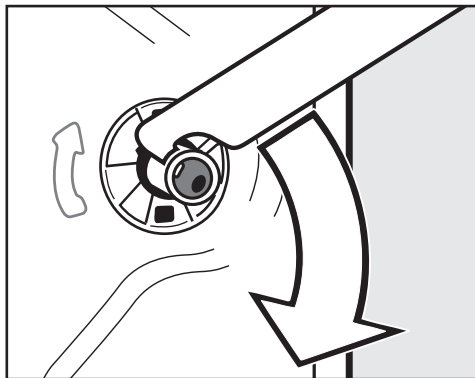

- Turn the right-hand transit bar 90°, then

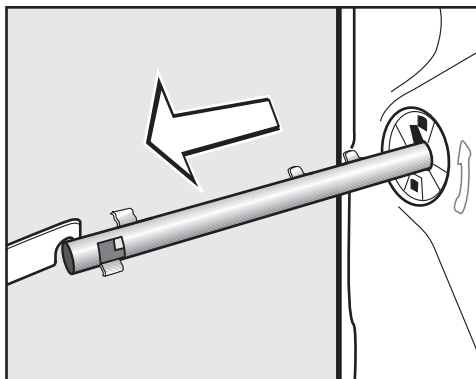

- pull the transit bar out.

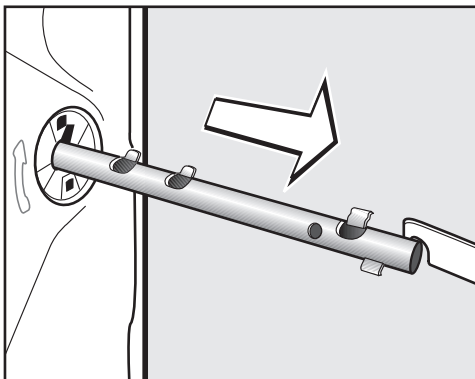

- pull the transit bar out.

## Installation and connection

 To avoid the risk of injury, the holes for the transit bars must be covered after the transit bars have been removed.

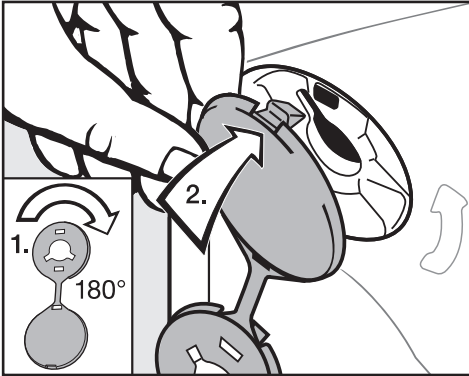

- Plug the holes with the plastic caps as illustrated.

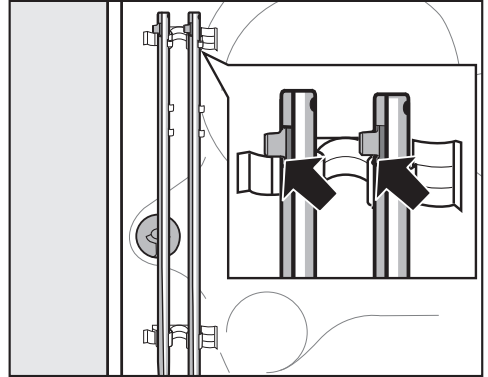

- Secure the transit bars to the back of the washing machine. Make sure the top catch is located above the holder.

 The washing machine must not be moved without the transit bars in place. Store them as shown or keep them in a safe place for future use. They must be re-fitted if the machine is to be moved again (e.g. when moving house).

### Re-fitting the transit bars

Re-fitting is carried out by reversing the procedure.

# Installation and connection

## Levelling the machine

The washing machine must stand perfectly level on all four feet to ensure safe and proper operation.

Incorrect installation may increase electricity and water consumption and may cause the machine to move about.

## Screwing out and adjusting the feet

The four adjustable screw feet are used to level the machine. All four feet are screwed in when the machine is delivered.

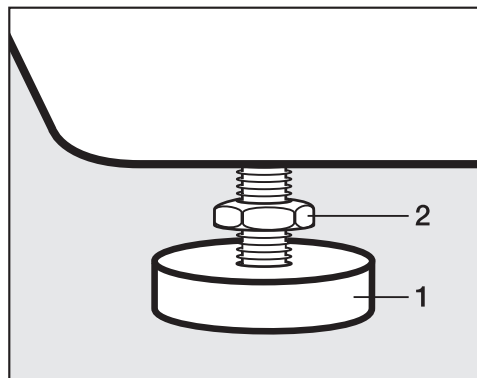

- Using the spanner supplied turn counter nut **2** in a clockwise direction. Then turn counter nut **2** together with foot **1** to unscrew.

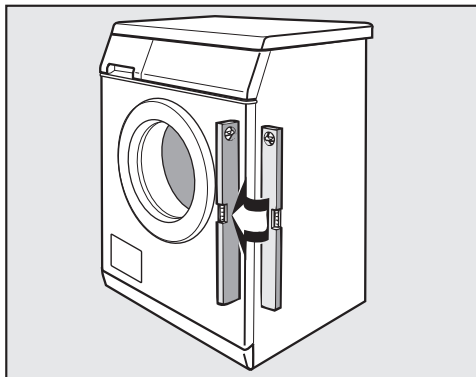

- Use a spirit level to check that the washing machine is standing level.
- Hold foot **1** securely with a pipe wrench. Turn counter nut **2** again using the spanner supplied until it sits firmly up against the housing.

 All four counternuts must be firmly up against the housing. Please also check this for the feet which did not need adjustment. Otherwise there is a danger of the machine moving about.

## Washer-dryer stack

The washing machine can be combined with a Miele tumble dryer in a washer-dryer stack. The appropriate "WTV" stacking kit\* to match your dryer is required.

All parts marked\* are available from your Dealer or Miele.

## Building under a continuous work-top/ in a kitchen run

Building under kits\* must only be installed/dismantled by a suitably qualified fitter in accordance with the instructions supplied.

- A special **building under kit\*** with a cover plate to replace the machine lid is required. It must be fitted by a suitably qualified fitter to ensure electrical safety. N.B. If there is space to push the washing machine under the worktop without removing the lid, the building under kit is not necessary. Otherwise it is essential.
- Connections for electricity, water and drainage should be installed in such a way that they remain accessible when the machine is in its final position.

Fitting instructions are supplied with the conversion kit.

## Please note:

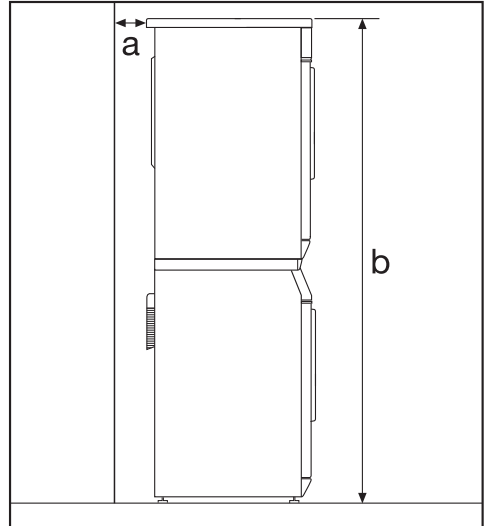

- a** Safety distance to wall at least 2 cm
- b** Height:  
Stacking kit with pull-out shelf: approx. 169 cm  
Stacking kit without pull-out shelf: approx. 170 cm

# Installation and connection

---

## The water protection system

The Miele water protection system protects all parts of the washing machine from water damage.

The system consists of three main components:

- the inlet hose
- the electronic unit and drainage and overflow protection
- the drain hose

### Inlet hose

- Protection against bursting

The inlet hose is tested to withstand pressure of at least 7,000 kPa.

## Electronic unit and washing machine housing

- Sump  
Any leaking water is collected in a sump in the base of the machine. A float switches off the water inlet valves, preventing any more water from flowing into the machine and water in the suds container is pumped away.
- Overflow protection  
This prevents the washing machine taking in too much water. If the water level exceeds a certain level, the drain pump switches in and pumps the excess water away.

### Drain hose

The drain hose is protected by a ventilation system which prevents the washing machine from being emptied completely.



## Connection to the water supply

The washing machine should be connected to a mains water supply in accordance with current local and national safety regulations. The German authorities do not require it to have a non-return valve as the washing machine has been designed to comply with DIN regulations.

The machine is designed to operate with a flow pressure of between 100 and 1,000 kPa. If it is higher than 1,000 kPa it is essential to fit a pressure reducing valve.

Connection to the mains water supply should incorporate a mains stopcock with  $\frac{3}{4}$ " threaded union. The stopcock should be fitted by a qualified plumber.

 The connection point is subject to mains water pressure. Turn on the stopcock slowly and check for leaks. Correct the position of the washer and union if appropriate.

The washing machine is not suitable for connection to a hot water supply.

## Maintenance

Only use a genuine Miele hose should you ever need a replacement or extension. These are tested to withstand pressure of at least 7,000 kPa.

In order to protect the water inlet valve, the two dirt filters (one in the open end of the inlet hose, the other in the inlet point in the machine) must not be removed.

## Extension hose

Longer hoses 2.5 or 4.0 m in length are available from your Miele Dealer or Miele as optional extras.

# Installation and connection

## Connection to the drainage system

The machine drains via a drain pump with a delivery head of 1 metre\*. The drain hose must not be kinked as this restricts drainage. The swivel elbow at the end of the hose can be turned in either direction, or can be detached if required, with a sharp twist and pull. If required, the drain hose can be extended to a length of 5 m. The necessary parts can be purchased from your Miele Dealer or Miele.

\* For a delivery head of more than 1 m (up to a max. of 1.8 m) a replacement drain pump will need to be fitted. Please contact Miele or your Miele Dealer for advice. If necessary, the drain hose can be extended to a length of 2.5 m. The necessary parts can be purchased from your Miele Dealer or Miele.

### Drain hose connection:

1. Direct into a sink or basin.

Please note the following:

- Hook the hose over the edge and secure.
- Make sure that the water can drain away freely without hindrance. Otherwise there is a risk of water overflowing or of some of the drained water being sucked back into the machine.

2. Connected securely to a plastic drain pipe with a rubber nipple. There is no need to use a non-return valve.

3. Connected securely to a floor gully.  
4. Connected securely to a standpipe.

Please note:

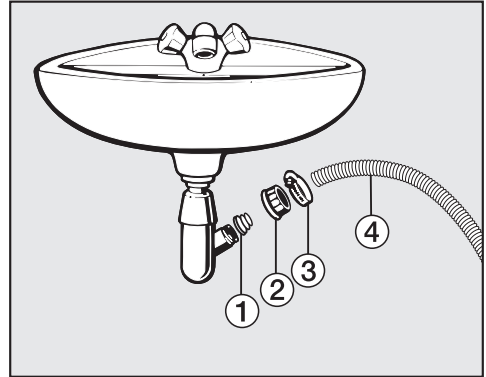

- ① Adapter
- ② Nut
- ③ Hose clip
- ④ End of the hose

- Fit adapter ① to the sink drain outlet using nut ②.
- Attach the end of the hose ④ to adapter ①.
- Use a screwdriver to tighten hose clip ③ up close to the nut.

### Electrical connection U.K.

All electrical work should be carried out by a suitably qualified and competent person, in strict accordance with current national and local safety regulations (BS 7671 in the UK).

Ensure power is not supplied to the appliance until after installation work has been carried out.

The appliance is supplied with a mains cable with moulded plug ready for connection to a 230-240V mains supply.

Please ensure the connection data quoted on the data plate match the household mains supply.

Connection should be made via a suitable switched socket which is easily accessible after installation.

For extra safety it is advisable to protect the machine with a suitable residual current device (RCD). Contact a qualified electrician for advice.

Do not connect via an extension lead. Extension leads do not guarantee the required safety of the appliance (e.g. danger of overheating).

### Non-rewireable plugs BS 1363

The fuse cover must be refitted when changing the fuse, and if the fuse cover is lost, the plug must not be used until a suitable replacement is obtained. The colour of the correct replacement cover is that of the coloured insert in the base of the plug, or the colour that is embossed in words on the base of the plug (as applicable to the design of plug fitted).

Replacement fuses should be ASTA approved to BS 1362 and have the correct rating. Replacement fuses and fuse covers may be purchased from your local electrical supplier.

### **WARNING: THIS APPLIANCE MUST BE EARTHED**

## Technical data

---

Height	850 mm
Width	595 mm
Depth	610 mm
Depth with door open	987 mm
Height for building under	820 mm
Width for building under	600 mm
Depth for building under	600 mm
Weight	Approx. 94 kg
Capacity	7 kg dry laundry
Voltage	See data plate
Connected load	See data plate
Fuse rating	See data plate
Consumption data	See "Consumption data"
Minimum flow pressure	100 kPa
Maximum flow pressure	1000 kPa
Inlet hose length	1.60 m
Drain hose length	1.50 m
Mains connection cable length	1.60 m
Delivery head max.	1.00 m
Maximum drainage length	5.00 m
LEDs	Class 1
Test certificates awarded	See data plate
Power consumption when switched off	0.30 W
Power consumption when not switched off	1.00 W

# Consumption data

		Load	Consumption data			
			Energy in kWh	Water in l	Duration	Residual moisture
Cottons	90°C	7.0 kg	2.20	52	2 h 29 min	52%
	60°C	7.0 kg	1.33	52	1 h 59 min	52%
	60°C	3.5 kg	1.00	45	1 h 59 min	52%
	◁60°C*	7.0 kg	0.94	52	2 h 59 min	52%
	◁60°C*	3.5 kg	0.82	45	2 h 59 min	52%
	40°C	7.0 kg	0.87	67	2 h 29 min	52%
	40°C	3.5 kg	0.76	45	2 h 29 min	52%
	◁40°C*	3.5 kg	0.58	45	2 h 59 min	52%
Minimum iron	40°C	3.5 kg	0.60	49	1 h 59 min	30%
Automatic plus	40°C	5.0 kg	0.52	62	1 h 29 min	–
Express 20	40°C	3.5 kg	0.32	30	20 min	–
Shirts	40°C	2.0 kg	0.50	42	54 min	–
Woolens 	30°C	2.0 kg	0.23	39	39 min	–
Delicates	30°C	2.0 kg	0.38	69	59 min	–

## Note for test institutes

\*Test programme in accordance with EN 60456 and energy label with Directive 1061/2010

Consumption data can vary from the nominal values given depending on water pressure, water hardness, water inlet temperature, room temperature, type and volume of load, fluctuations in the electricity supply and any options selected.

# Programmable functions

---

The programmable functions are used to alter the machine's electronics to suit changing requirements. Programmable functions can be altered at any time.

## Water plus system

This programmable function is used to specify one of three options for the *Water plus* button.

*P1:*

(Factory default setting)

The water level is increased in the wash and rinse stages.

*P2:*

An extra rinse is carried out.

*P3:*

The water level is increased in the wash and rinse stages and an extra rinse is carried out.

### Follow steps ① to ⑦ to programme and store in memory.

The programmable functions are accessed via the Start button and the programme selector.

Before you begin, ensure that:

- The washing machine is switched off.
- The machine door is closed properly.
- The programme selector is at *Finish*.

- ① Press the *Start* button and keep it pressed in whilst carrying out steps ② to ③.
  - ② Switch machine on with the ① button.
  - ③ Wait until the indicator light for the *Start* button lights up constantly . . .
  - ④ . . . and then release the Start button.
  - ⑤ Turn the programme selector to *Cottons 60°C*.
- A *P* will flash in the display alternating with the number 1, 2 or 3.
- ⑥ Each subsequent press on the *Start* button selects a different option and *P* will flash alternately in the display with the number of the option selected.
  - ⑦ Switch the washing machine off with the ① button.

## Gentle action

Activating gentle action reduces the drum action and is suitable for washing lightly soiled items more gently.

Gentle action can be activated for the Cottons and Minimum iron programmes.

The washing machine is delivered with the Gentle action setting deactivated.

### Follow steps ① to ⑦ to programme and store in memory.

The programmable functions are accessed via the Start button and the programme selector.

Before you begin, ensure that:

- The washing machine is switched off.
- The machine door is closed properly.
- The programme selector is at *Finish*.

- ① Press the *Start* button and keep it pressed in whilst carrying out steps ② to ③.
- ② Switch machine on with the ① button.
- ③ Wait until the indicator light for the *Start* button lights up constantly . . .
- ④ . . . and then release the Start button.
- ⑤ Turn the programme selector to *Cottons*  $\langle 60^{\circ}\text{C} \rangle$ :  
A *P* will flash in the display alternating with the number  $\bar{0}$  or  $\bar{1}$ .
- ⑥ Pressing the *Start* button switches the programmable function on or off. If *P* flashes in the display alternating with the number  $\bar{1}$ , the programmable function is switched on. If *P* flashes in the display alternating with the number  $\bar{0}$ , the programmable function is switched off.
- ⑦ Switch the washing machine off with the ① button.

# Programmable functions

---

## Suds cooling

When this is activated, additional water flows into the drum at the end of the main wash to cool the suds down. Hot suds can damage plastic drainage pipes.

Suds cooling takes place when a temperature of 90°C or higher is selected for the Cottons programme.

Suds cooling should be activated:

- to prevent the danger of scalding if the drain hose is hooked over the edge of a sink or basin.
- where drainage pipes do not comply with DIN 1986.
- The machine is delivered with Suds cooling deactivated.

### Follow steps ① to ⑦ to programme and store in memory.

The programmable functions are accessed via the Start button and the programme selector.

Before you begin, ensure that:

- The washing machine is switched off.
- The machine door is closed properly.
- The programme selector is at *Finish*.

- ① Press the *Start* button and keep it pressed in whilst carrying out steps ② to ③.
- ② Switch machine on with the ① button.
- ③ Wait until the indicator light for the *Start* button lights up constantly . . .
- ④ . . . and then release the Start button.
- ⑤ Turn the programme selector to *Cottons 40°C*  
A *P* will flash in the display alternating with the number *0* or *1*.
- ⑥ Pressing the *Start* button switches the programmable function on or off. If *P* flashes in the display alternating with the number *1*, the programmable function is switched on. If *P* flashes in the display alternating with the number *0*, the programmable function is switched off.
- ⑦ Switch the washing machine off with the ① button.



## Memory

If an extra option is selected for a programme and / or the spin speed is altered, the washing machine stores these changes in memory at the start of a programme.

When that particular programme is chosen again, the washing machine will display the extra option and / or the spin speed which have been stored for that programme in memory.

The machine is delivered with the memory function deactivated.

### Follow steps ① to ⑦ to programme and store in memory.

The programmable functions are accessed via the Start button and the programme selector.

Before you begin, ensure that:

- The washing machine is switched off.
- The machine door is closed properly.
- The programme selector is at *Finish*.

- ① Press the *Start* button and keep it pressed in whilst carrying out steps ② to ③.
- ② Switch machine on with the ① button.
- ③ Wait until the indicator light for the *Start* button lights up constantly . . .
- ④ . . . and then release the Start button.
- ⑤ Turn the programme selector to *Cottons*  $\langle 40^{\circ}\text{C} \rangle$ .

A *P* will flash in the display alternating with the number  $\bar{0}$  or  $\bar{1}$ .

- ⑥ Pressing the *Start* button switches the programmable function on or off. If *P* flashes in the display alternating with the number  $\bar{1}$ , the programmable function is switched on. If *P* flashes in the display alternating with the number  $\bar{0}$ , the programmable function is switched off.
- ⑦ Switch the washing machine off with the ① button.

# Programmable functions

---

## Soak duration

A soak duration of between 30 minutes and 2 hours can be programmed in 30 minute increments for the *Soak* button.

If the *Soak extra* option is selected, the soaking process will be carried out for the duration set before the wash programme is run.

The machine is delivered with a 2 hour duration set for the *Soak* button.

### Follow steps ① to ⑦ to programme and store in memory.

The programmable functions are accessed via the *Start* button and the programme selector.

Before you begin, ensure that:

- The washing machine is switched off.
- The machine door is closed properly.
- The programme selector is at *Finish*.

- ① Press the *Start* button and keep it pressed in whilst carrying out steps ② to ③.
- ② Switch machine on with the ① button.
- ③ Wait until the indicator light for the *Start* button lights up constantly . . .
- ④ . . . and then release the *Start* button.
- ⑤ Turn the programme selector to *Cottons 30°C*

A *P* will flash in the display alternating with the number 1, 2, 3 or 4.

- 1 = 2 h soak duration (factory default setting)
- 2 = 1 h 30 min soak duration
- 3 = 1 h soak duration
- 4 = 30 min soak duration

- ⑥ Each subsequent press on the *Start* button selects a different option and *P* will flash alternately in the display with the number of the option selected.
- ⑦ Switch the washing machine off with the ① button.

Detergent, fabric care, additives and machine care products are available for this washing machine. All the products have been designed for Miele washing machines.

These and many other useful products can be ordered via the internet at [www.miele-shop.com](http://www.miele-shop.com) or from Miele (see end of this booklet for contact details).



### Detergent

#### UltraWhite

- powder detergent
- suitable for white and light coloured laundry as well as heavily soiled cotton items
- effective stain removal even at low temperatures

#### UltraColor

- liquid detergent for coloureds
- suitable for coloured and dark/black garments
- protects bright colours from fading
- effective stain removal even at low temperatures

#### Wool and delicates detergent

- liquid detergent for delicates
- particularly suitable for woollen and silk garments
- cleans at temperatures as low as 20°C, helps retain the shape of delicate garments and protect colours

### Specialist detergents

#### Outerwear

- liquid detergent for outerwear and performance clothing
- cleans with care and is gentle on colours
- with lanolin to care for and condition membrane fabric

#### Sports

- liquid detergent for sportswear and fleece garments
- neutralises unpleasant odours
- retains the shape of the textiles

#### Down items

- liquid detergent suitable for pillows, sleeping bags and down filled items
- retains the elasticity of down and feather filled items
- retains the breathability of down filled items
- prevents down filling clumping together

# Optional accessories

---

## Fabric care

Fabric care agents are available as capsules ☼ in convenient single dose amounts or in a handy bottle.

### Reproofing agent

- for reproofing microfibre garments e.g. rain coats etc.
- retains the breathability of garments

### Fabric conditioner

- fresh, natural fragrance
- makes laundry soft to handle

## Machine care products

### Machine cleaner

- for cleaning the washing machine thoroughly and effectively
- removes grease, bacteria and unpleasant odours

### Descaling agent

- removes heavy limescale deposits
- mild and gentle with natural citric acid





## United Kingdom

Miele Co. Ltd.  
Fairacres, Marcham Road  
Abingdon, Oxon, OX14 1TW  
Customer Contact Centre Tel: 0330 160 6600  
E-mail: mielecare@miele.co.uk  
Internet: www.miele.co.uk

## Australia

Miele Australia Pty. Ltd.  
ACN 005 635 398  
ABN 96 005 635 398  
1 Gilbert Park Drive, Knoxfield, VIC 3180  
Tel: 1300 464 353  
Internet: www.miele.com.au

## China

Miele (Shanghai) Trading Ltd.  
1-3 Floor, No. 82 Shi Men Yi Road  
Jing' an District  
200040 Shanghai, PRC  
Tel: +86 21 6157 3500, Fax: +86 21 6157 3511  
E-mail: info@miele.cn, Internet: www.miele.cn

## Miele (Hong Kong) Limited

41/F - 4101, Manhattan Place  
23 Wang Tai Road  
Kowloon Bay, Hong Kong  
Tel: (852) 2610 1331, Fax: (852)2610 1013  
Email: mielehk@miele.com.hk

## India

Miele India Pvt. Ltd.  
Ground Floor, Copia Corporate Suites  
Plot No. 9, Jasola  
New Delhi - 110025  
Tel: 011-46 900 000, Fax: 011-46 900 001  
E-mail: customercare@miele.in, Internet: www.miele.in

## Ireland

Miele Ireland Ltd.  
2024 Bianconi Avenue  
Citywest Business Campus, Dublin 24  
Tel: (01) 461 07 10, Fax: (01) 461 07 97  
E-Mail: info@miele.ie, Internet: www.miele.ie

## Manufacturer: Miele & Cie. KG

Carl-Miele-Straße 29, 33332 Gütersloh, Germany

# Miele

## Malaysia

Miele Sdn Bhd  
Suite 12-2, Level 12  
Menara Sapura Kencana Petroleum  
Solaris Dutamas No. 1, Jalan Dutamas 1  
50480 Kuala Lumpur, Malaysia  
Phone: +603-6209-0288  
Fax: +603-6205-3768

## New Zealand

Miele New Zealand Limited  
IRD 98 463 631  
Level 2, 10 College Hill  
Freemans Bay, Auckland 1011, NZ  
Tel: 0800 464 353  
Internet: www.miele.co.nz

## Singapore

Miele Pte. Ltd.  
163 Penang Road  
# 04 - 03 Winsland House II  
Singapore 238463  
Tel: +65 6735 1191, Fax: +65 6735 1161  
E-Mail: info@miele.com.sg  
Internet: www.miele.sg

## South Africa

Miele (Pty) Ltd  
63 Peter Place, Bryanston 2194  
P.O. Box 69434, Bryanston 2021  
Tel: (011) 875 9000, Fax: (011) 875 9035  
E-mail: info@miele.co.za  
Internet: www.miele.co.za

## United Arab Emirates

Miele Appliances Ltd.  
P.O. Box 11 47 82  
Gold & Diamond Park, Sheikh Zayed Road  
Building 6 / Offices Nos. 6-214 to 6-220  
Dubai  
Tel: +971-4-341 84 44  
Fax: +971-4-341 88 52  
E-Mail: info@miele.ae  
Internet: www.miele.ae

WDA 110



en-GB

M.-Nr. 09 900 700 / 01